

**COR-A-VENT TYPICAL SIDE VIEWS
& OTHER VENTS AND ACCESSORIES**

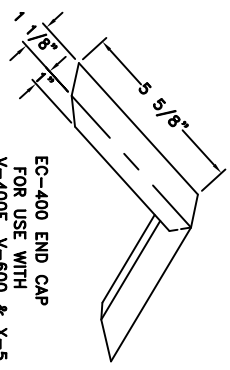
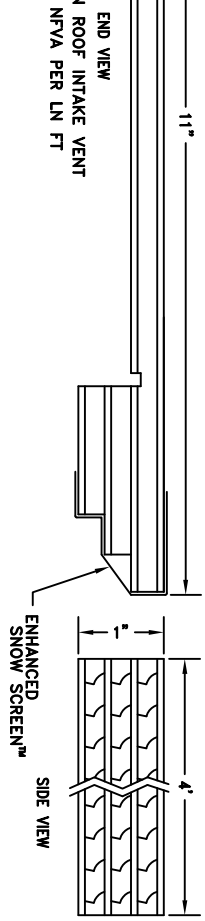
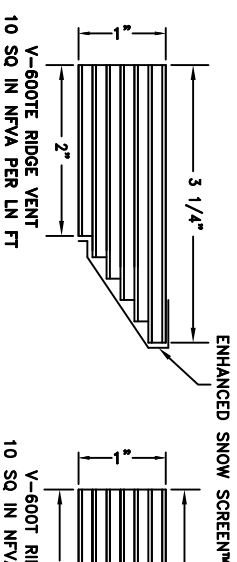
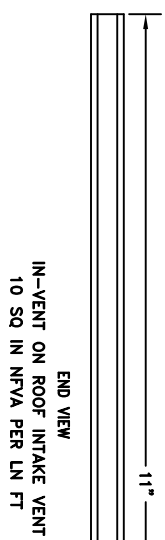
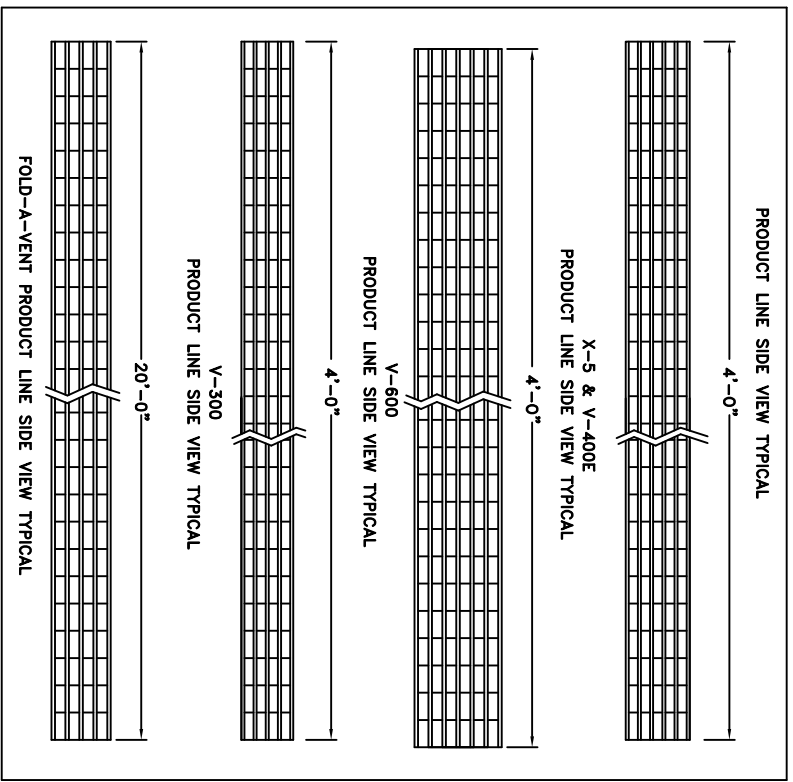
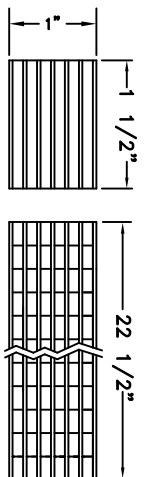
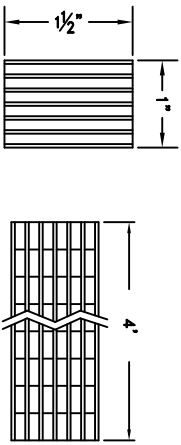
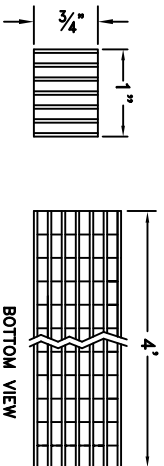
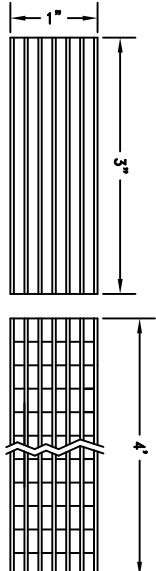
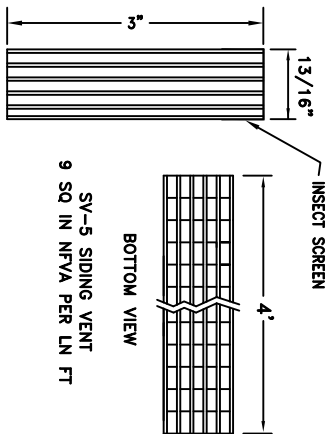
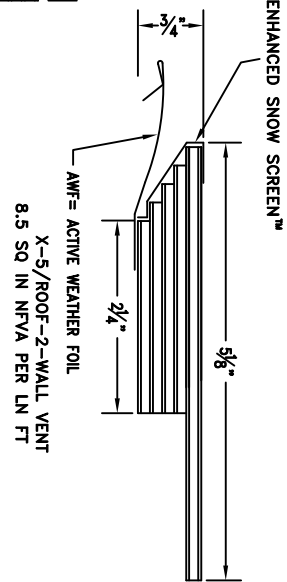
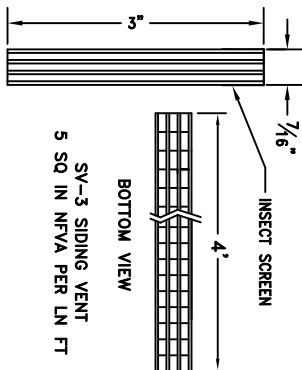

This material may be duplicated only for the purpose of specifying Cor-A-Vent products. No permission is given to duplicate this material for any other purpose without the express written permission of Cor-A-Vent Inc. ©2007 COR-A-VENT, INC.

P.O. BOX 428 MISHAWAKA, IN 46546-0428
800-837-8368
COR-A-VENT, INC.
APPROVED BY: G. SELLS
DATE: 09/01/07
ARCHITECT REF. DRAWING
DRAWING NUMBER: COR-EV2