

COR-A-VENT® Installation and Information Guide.

Easy Installation: One person can easily install the handy four-foot COR-A-VENT sections. All you need is a hammer, circular saw, chalk line, utility knife, tape measure and a caulking gun. Here's an installation overview for a standard pitch* gable roof application:

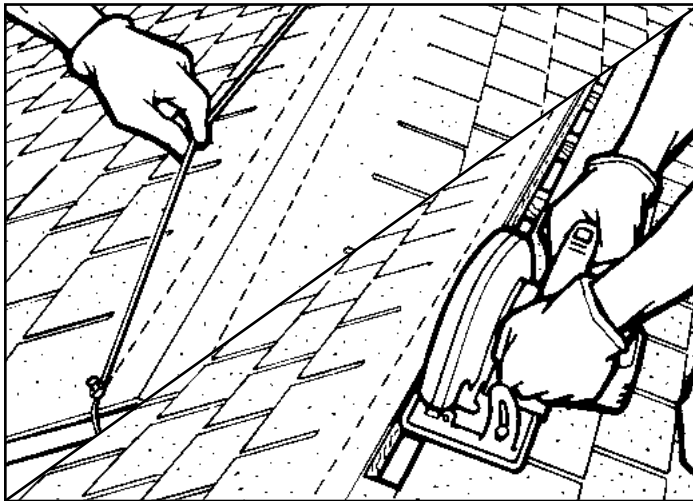

1. Measure a 3" slot, 1½" each side of ridge centerline. This allows for a 2x ridge board or smaller. Snap chalk lines the entire length of the ridge. Cut slot with a circular saw and clean out debris. Set saw depth so as not to cut roof rafters. Stop the slot 12" short of any ridge end, intersecting ridge or obstruction (such as a chimney). **If Architectural Shingles, Shakes or roofing with an irregular surface is used, apply a bead of caulk to roof deck before installing vent. This will seal any gaps that could allow weather penetration under the vent.**

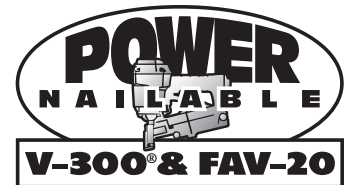
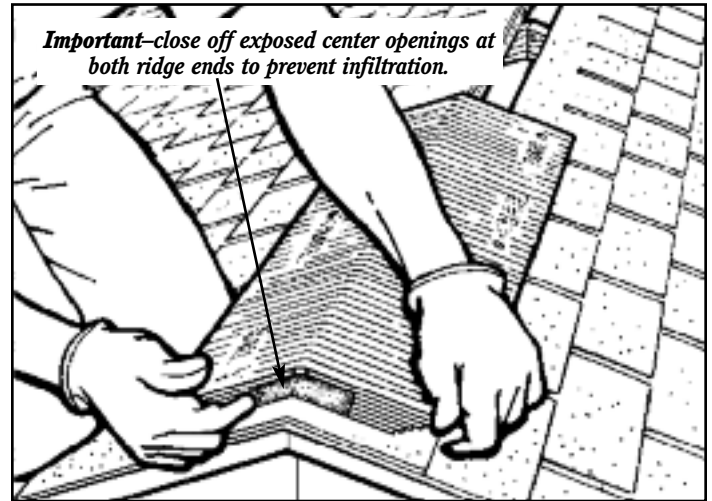

2. Nail one shingle cap at each end of the ridge, as with conventional application. Use End Plug in the exposed end on first and last sections of vent, caulk in place. Center first piece on ridge and nail, keeping end of vent ½" from end of roof. Set 4 nails ½" from ends and 2" up from edge on each corner of vent, add 2 nails in center of vent 2" up from edge. Repeat this step at the other end of the ridge. For V-300, use the Folded End Cap technique shown on back page.

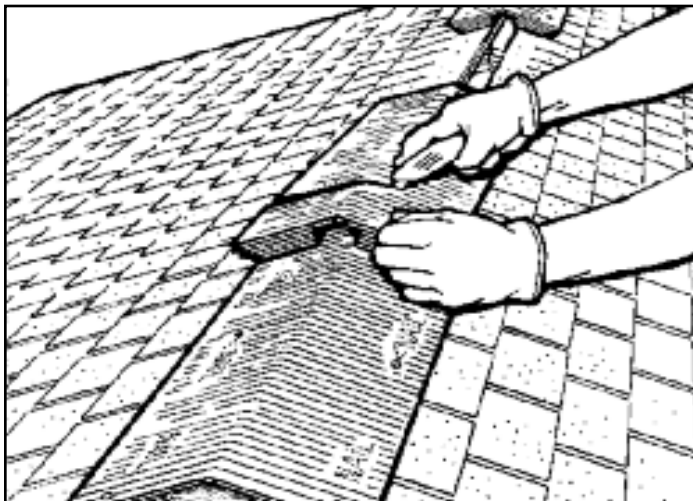

3. Continue applying COR-A-VENT, **working from ends to middle.** This technique helps remove any dips or sag in the ridge. Align center with previous pieces, making sure vent matches roof pitch before nailing. Continue nailing until entire ridge is covered. Use a utility knife to cut last piece to length. Caulk where bottom edge of end caps rest on roof.

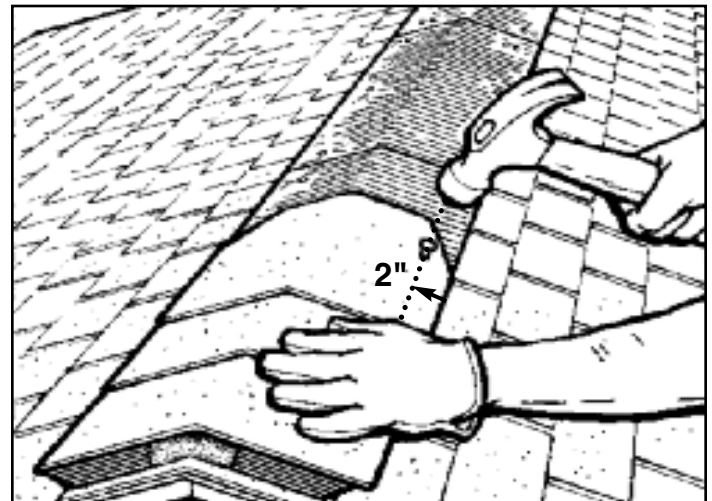

4. Center shingle cap on vent and nail. Nail line for cap shingles is to be 2" - 2½" up from edge. Continue nailing until all vent is covered with ridge caps. Be careful not to overdrive nail. Nail head should be flush with top of shingle, without indenting it. Pre-forming caps in cold weather helps avoid cracking.

Be sure to use fasteners long enough to penetrate vent and roof deck when nailing the vent and ridge cap on. Heavyweight, architectural and re-roof installations require a longer nail than the standard installation.**

In high wind areas, use a washer headed nail to prevent shingle cap "blow off". Or, apply a ¼" to ⅜" bead of roof cement between the ridge caps, ¾" up from the bottom edge of shingles parallel to ridge.

COR-A-VENT Ridge Vents are sized for residential and light commercial buildings up to 60 feet wide. Please call COR-A-VENT before using our ridge vents on buildings wider than 60 feet.

*Standard applications V-300® or V-600® - 3/12 - 16/12 pitch. For steeper pitch/wide ridge beam applications see complete installation sheet or see us on the web at www.cor-a-vent.com.

**Nail requirements for standard vent and ridge cap installation: V-600 - 2½" roofing nail, V-300 - 1½" (with 3 tab shingles installed on new construction or after complete roof tear off).

Hip Installation Instructions

If the ridge length is too short to install the recommended amount of ventilation, COR-A-VENT® V-300®E, FAV-20E (Fold-A-Vent®), or V-600®E may be installed in equal lengths on the upper half of the hips. These instructions can be used for most shingle, shake or slate applications.

If jack rafters are 16" on center, cut the slot per our ridge installation instructions. If jack rafters are 24" on center, blocking may be needed to prevent the roof sheathing from sagging. Cut 2" x 4" blocks 8" long, and using 16-penny nails, nail blocks between jack rafters and flush with bottom of roof sheathing. Cut the slot per our ridge installation instructions. The blocks will provide support for the roof sheathing. Nail roof sheathing to blocks with 8-penny nails. See Fig. A below. **Note: When using blocking, allow for a loss of 25% in ventilation due to the blocks.**

The slot normally does not need to be cut more than half way down the hips for open attic roofs. The vent may be run all the way down to the end of the roof for appearance reasons, BUT DO NOT CUT A SLOT UNDER IT! This will insure that the air is drawn in from the soffit inlet vents and exhausted out through the ridge and/or hip vents.

If it is an ALL cathedral ceiling roof then the slot must not be cut any closer than 3 feet up from the outside wall of the building. This will prevent any ice build up from leaking back into the building. In areas that receive heavy snowfall, the slot should stop 6 feet up from the outside wall of the house. The vent may be run all the way down to the end of the roof for appearance reasons, BUT DO NOT CUT A SLOT UNDER IT! See Fig. B below for details on how to cut the vent where the hips and ridge come together. The vent can be cut with a utility knife. Caulk all joints with black silicon caulking. Also, caulk end joints on the vent coming up the hip. Using the 20-foot FAV-20E (Fold-A-Vent) will eliminate most joints on the hip itself. (See main drawing below.)

If 3 in 1 shingles are used, run a 3/8" bead of silicon caulking down each side of the slot, centered on the nailing surface of the vent. This will insure that the vent is sealed down across the shingle courses and prevent water from weeping in under the vent.

If Heavy Weight Shingles, Shakes, Slate or Tiles are used: see Fig. C below for a detail on how to install a batten strip to provide a level surface for the vent to sit on. Batten strips need to be as thick as the thickest point of the roofing. There **MUST NOT BE ANY GAPS UNDER THE VENT** or water may leak in.

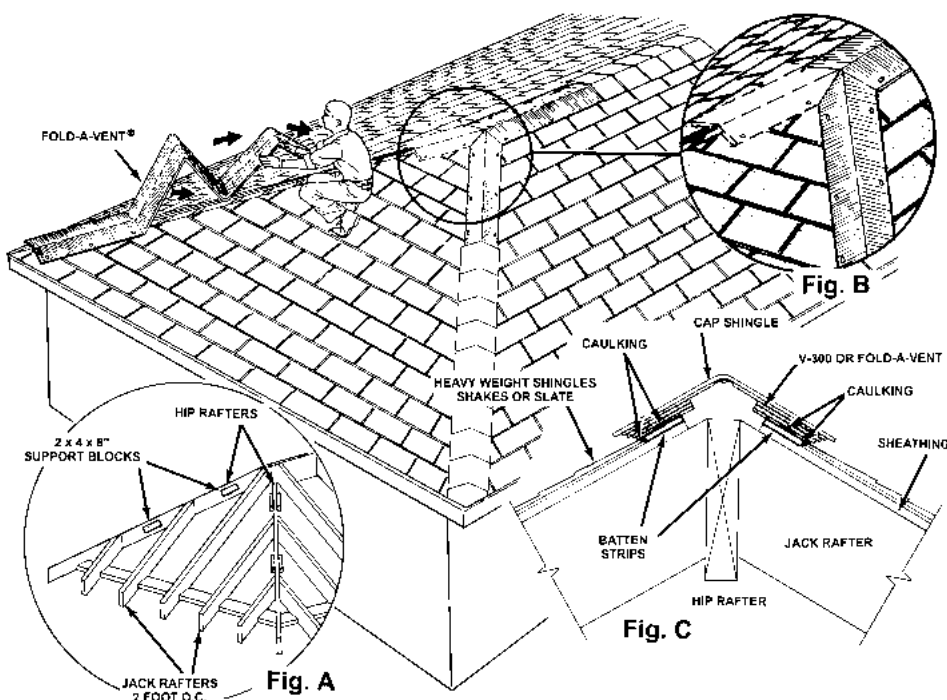

MINIMUM ROOF PITCH FOR INSTALLATION - 5/12

End Views

COR-A-VENT RIDGE VENTS W/ENHANCED SNOW SCREEN END VIEWS TYPICAL

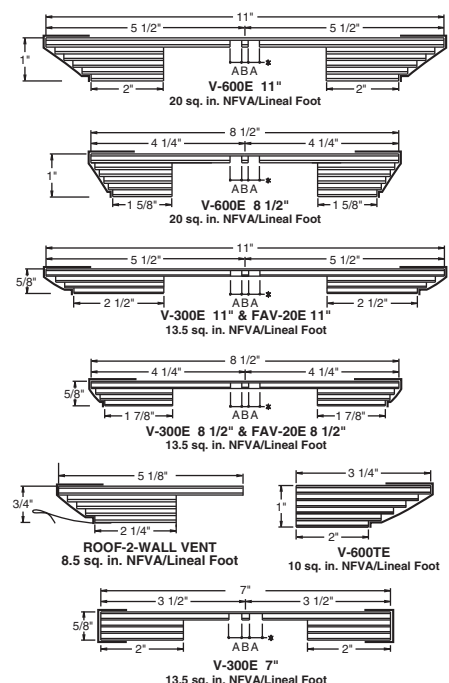

COR-A-VENT RIDGE VENTS NON-ENHANCED END VIEWS TYPICAL

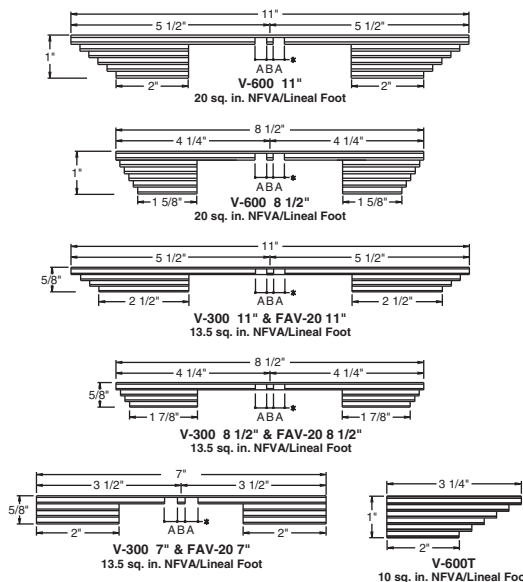

COR-A-VENT SPECIALTY APPLICATIONS

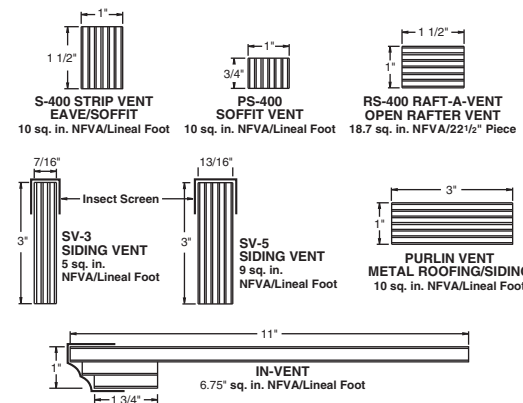

* A=5/16" * B=3/16" AWF=Active Weather Foil

Alternate Installation Examples:

COR-A-VENT® continually develops and improves applications to meet the growing demands of architecture and new roofing materials. The specialized details on this page have been proven in thousands of real world installations. We don't experiment on your job.

Call our technical dept. for advice on your special application. Or, send us a print and we'll "mark up" where and how to vent it. **Our Enhanced products can be substituted whenever an extra measure of protection is needed.**

V-300/V-600 Steep Pitch Application (Standard)

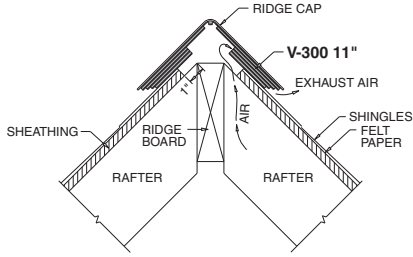

V-600 Half Piece Wide Ridge Application

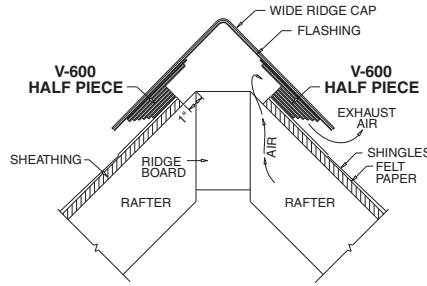

**Roof-2-Wall Vent™
Roof to Wall Application
Shingle Roof**

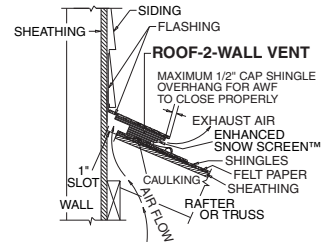

S-400 Shed Roof Application

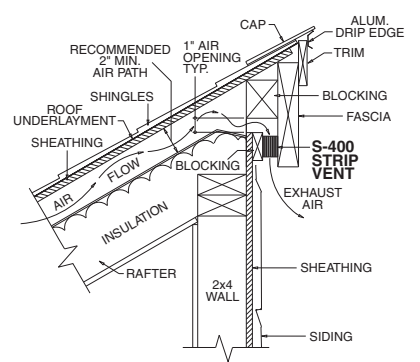

V-300 8 1/2" / FAV 8 1/2" Ridge Application

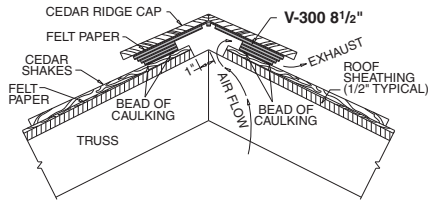

V-300E 8 1/2" / FAVE 8 1/2" Hip Application - End View

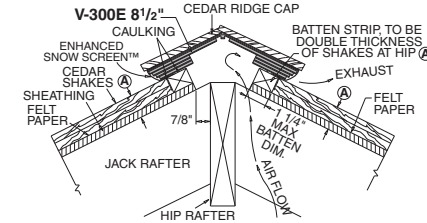

Roof-2-Wall Unequal Pitch Application

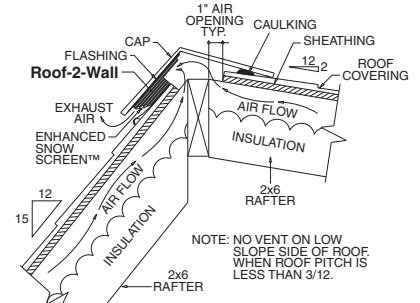

V-600T - "S" Tile Application (W/Air Dam Flashing Detail)

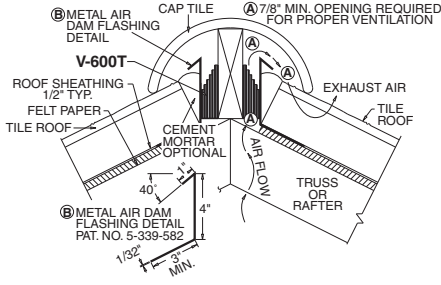

V-300 8 1/2" Flat Tile Application

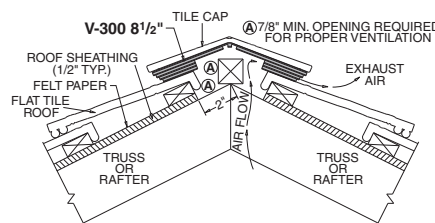

V-600TE Standing Seam Application

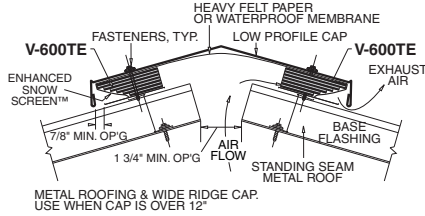

V-600T - Profile Metal Roof Application

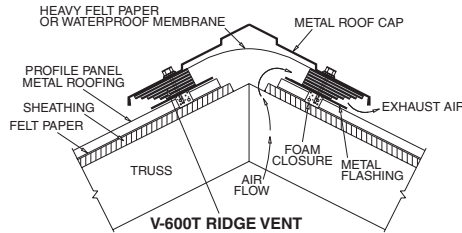

S-400 Strip Vent - Narrow Overhang Application

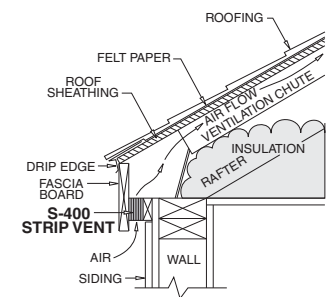

V-600 11" - Architectural Metal Roof Application

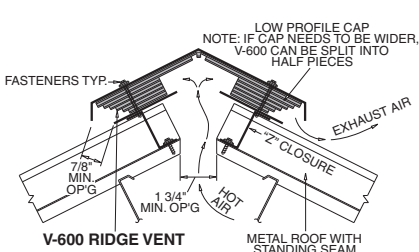

V-600TE Standing Seam Application Roof to Wall

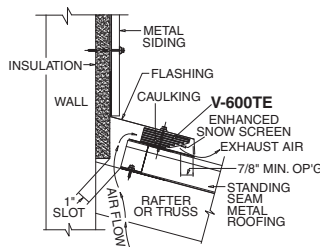

S-400 Strip Vent - Wide Overhang Application

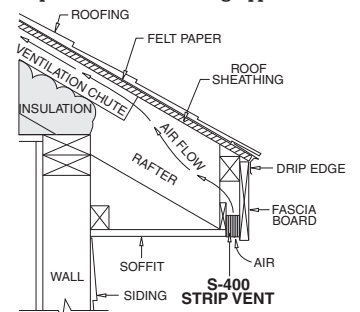

COR-A-VENT Folded End Cap Instructions:

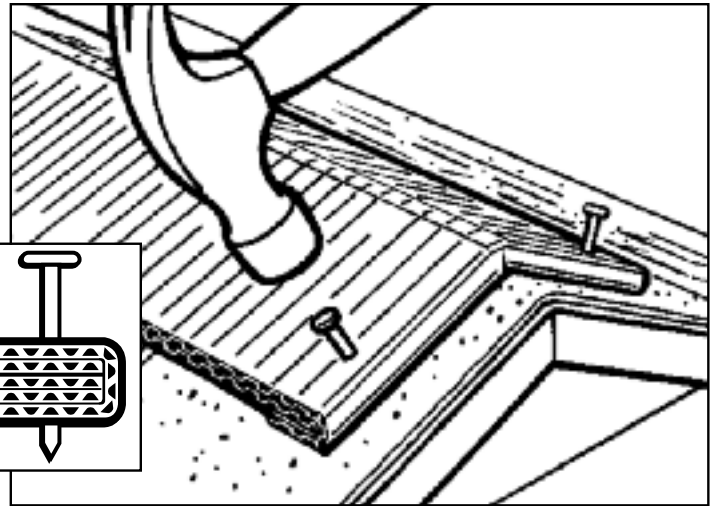
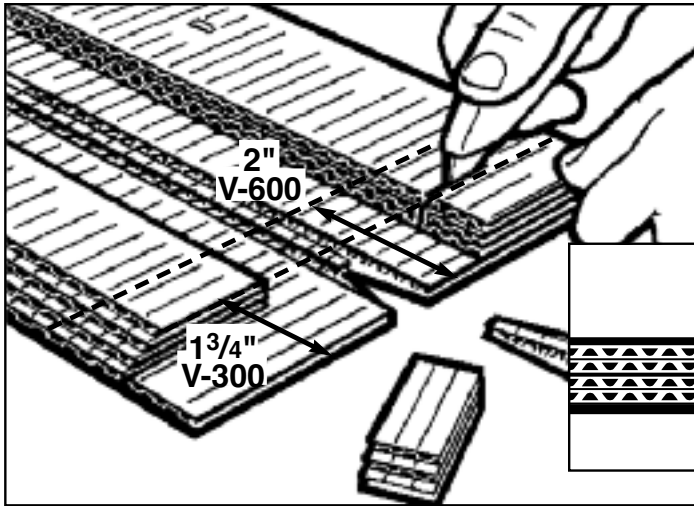

1. Turn vent piece (V-300 shown) over so routed slot is facing up. Use utility knife to cut out a "V" shaped notch in one end of vent.

2. Measure 1 3/4" from end of vent and make a parallel cut through bottom 3 layers. For V-600, measure 2" from end and cut through bottom 5 layers. Remove loose pieces. Be careful not to cut off top layer!!

3. Fold end flap under and secure with a roofing nail – 2" for V-300 or 2 1/2" for V-600. This allows for the nail to penetrate an extra layer of vent material.

4. Nail vent pieces to roof per instructions above. Be sure to caulk between bottom edge of vent and roof at both ends of the ridge.

Be careful not to touch knife blade. Always cut in a direction away from yourself. Wear proper hand and eye protection.

For the best appearance, install COR-A-VENT continuously the entire length of the ridge.

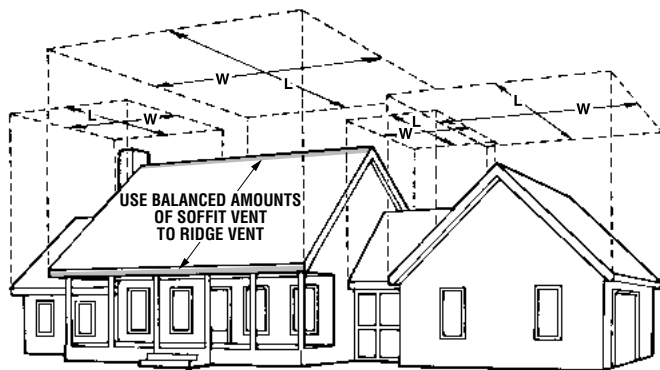

Figuring Your Ventilation Needs:

V-600 = 20 Sq. inches NFVA/lineal foot. V-300 = 13.5 Sq. inches NFVA/lineal foot.

V-600: $\frac{\text{Square footage of building footprint} \times .48}{20}$ = Lineal Feet V-600 needed

V-300: $\frac{\text{Square footage of building footprint} \times .48}{13.5}$ = Lineal Feet V-300 needed

Example: 25' x 50' = 1250 Sq.F.

1250 x .48 = 600

600 ÷ 20 = 30 L.F. V-600 needed

The above formulas will give the amount of COR-A-VENT ridge vent needed for a 1/150 vent ratio, provided an equal or greater amount of soffit venting is used. For a 1/300 ratio, (building code minimum) use half the amount of ridge vent.

Note: Code interpretation may vary. Consult your local building dept.

Balanced Ventilation is not only having an equal amount of ridge and soffit vents in net free inches, but having the soffit and ridge vents balance each other on the structure. Wherever there is ridge vent above, there should be soffit/eave/intake vents on the structure below.

Important notes: COR-A-VENT ridge vents should *always* be installed with soffit/eave/intake vents of equal or greater area. *All other vent openings (except soffits) should be closed off.* The air passage way or "Ventilation Chute" between the inlet (soffit/eave/intake) and the outlet (ridge) vent must not be blocked or restricted.

Call our technical service dept. for help with any standard or specialty ridge or soffit applications.

Our website contains a complete listing of application details in .PDF and .DWG formats for viewing or downloading.

"This material may be duplicated only for the purposes of specifying COR-A-VENT® products. No permission is given to duplicate or otherwise copy this material for any other purpose without the express written permission of COR-A-VENT, Inc."



A Trusted Name in Attic Ventilation Since 1976®

COR-A-VENT, INC.

P.O. Box 428 • Mishawaka, IN 46546-0428
Phone: (800) 837-8368 Fax: (800) 645-6162
info@cor-a-vent.com • www.cor-a-vent.com